

Article number: 51030524000010

Description: Vibration damper GS-M2
150x100x2000-10, NR shore 57

Measures

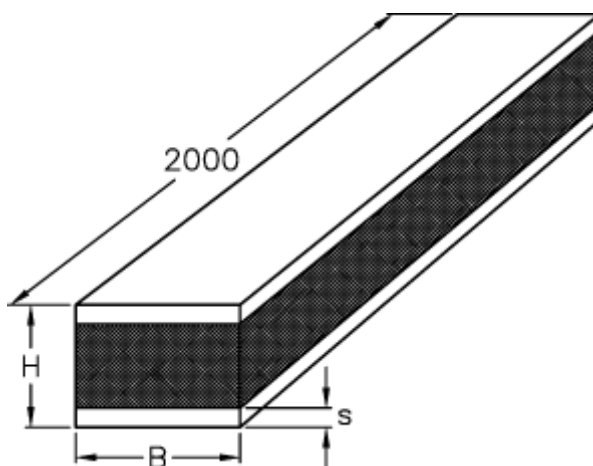

B = 150
H = 100
S = 10